



S7

7 Ah | 6 V | 20 h

Specifications

Voltage	6 V
Nominal Capacity	7 Ah @ 20 hour-rate
Number of Cells	3
Internal Resistance	Approx. 15 mΩ
Design Life	6 to 8 years (float charging)
Short Circuit Current	350 A
Self Discharge	Monthly rate < 3% @ 25 °C Recharge after 6 months Charge before using

Temperature Ranges

Normal Operation	25 °C ± 5 °C
Discharging	-20 °C to 60 °C
Charging	0 °C to 50 °C
Storage	-20 °C to 60 °C

Charging & Discharging

Max. Charging Current	2.10 A
Max. Discharge Current	70 A (5 sec)
Standby Use Voltage	6.85 V to 6.94 V @ 25 °C Temperature Compensation: -3mV/°C/Cell
Cycle Use Voltage	7.30 V to 7.40 V @ 25 °C Temperature Compensation: -4mV/°C/Cell
Reference Capacity	C3 5.4 Ah C5 6.1 Ah C10 6.5 Ah C20 7 Ah

Mechanical Specifications

Measurements (L x W x H)	151 x 34 x 94 mm
Weight	Approx. 1.0 kg
Terminals	F1
Case material	A.B.S. UL94-HB, UL94-V0 Optional

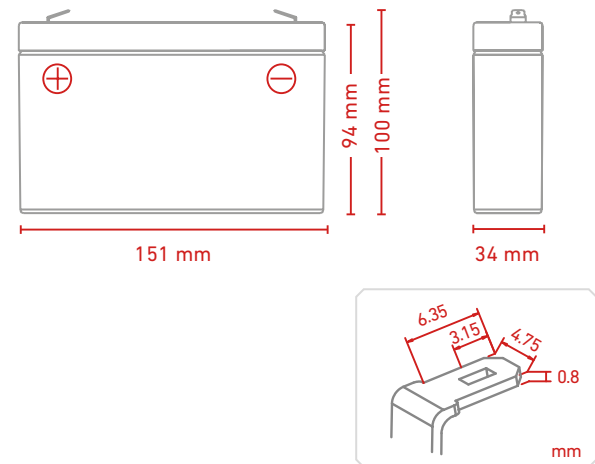

Discharge Characteristics Curve

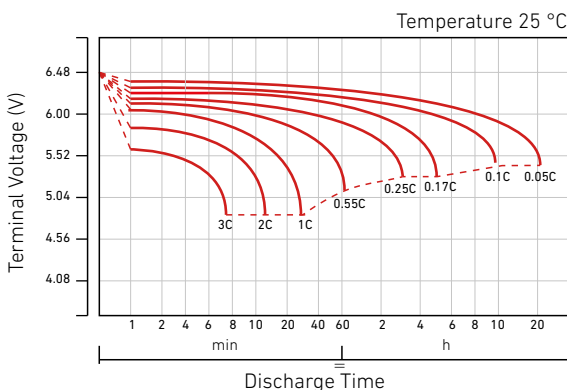

Cycle Life in Relation to Depth of Discharge

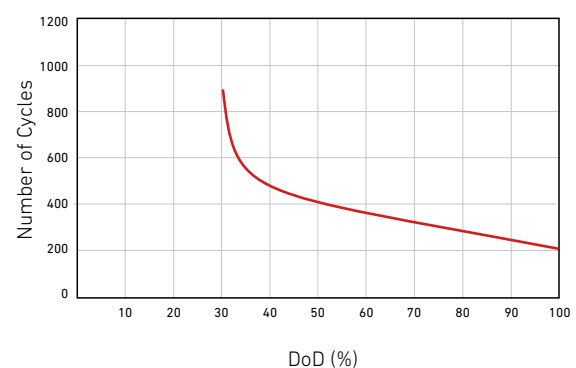

Discharge Characteristics Curve For Standby Use

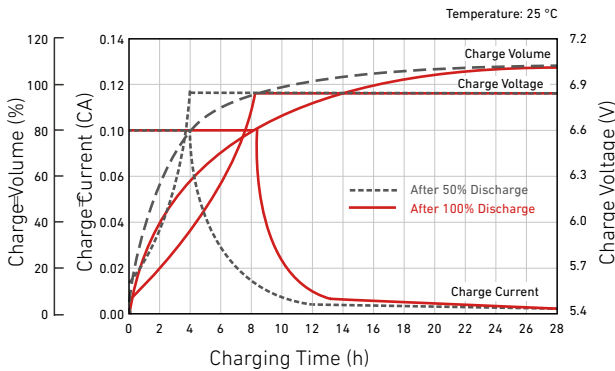

Relationship Between Charging Voltage and Temperature

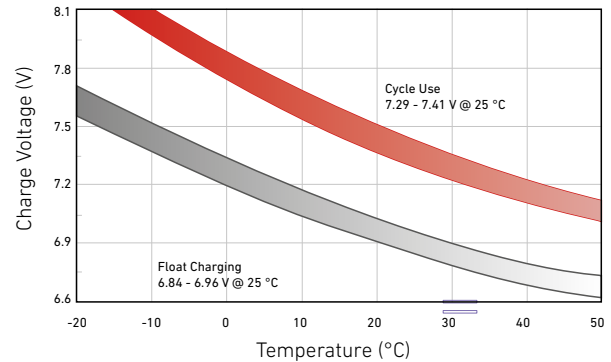

Temperature Effects on Capacity

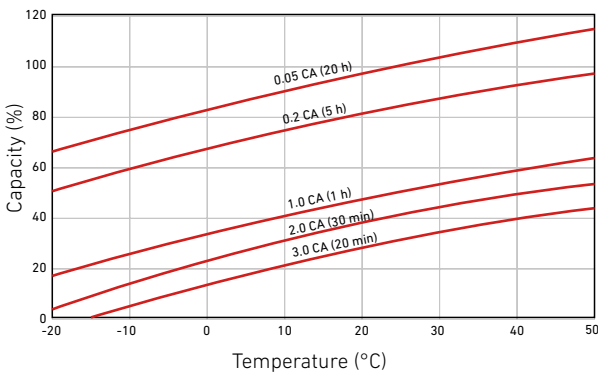

Storage Characteristics

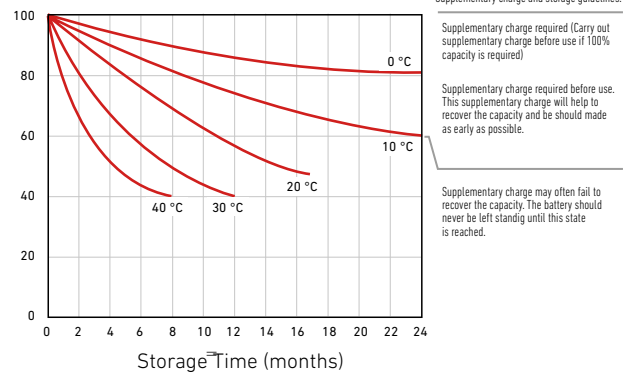

Effect of Temperature on Long-Term Life

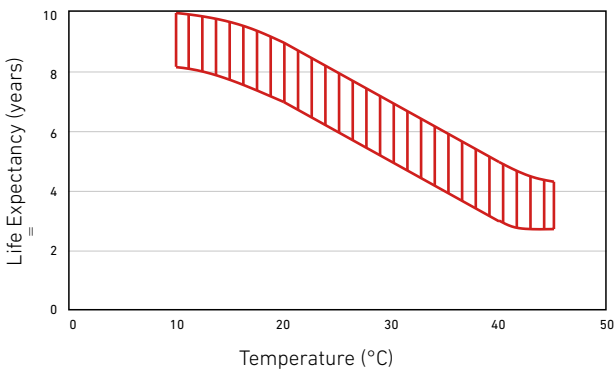

Life Characteristics of Standby Use

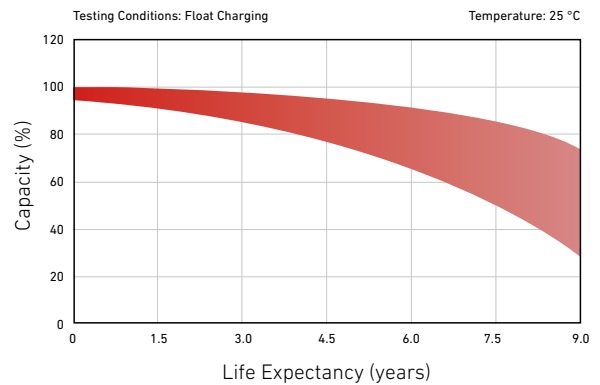

Constant Current Discharge Characteristics: A (25 °C)

F.V	Time											
	5 min	10 min	15 min	30 min	1 h	2 h	3 h	4 h	5 h	8 h	10 h	20 h
1.60 V	27,75	18,10	13,35	7,728	4,465	2,634	1,915	1,525	1,287	0,860	0,701	0,364
1.65 V	26,75	17,56	13,00	7,558	4,382	2,596	1,890	1,506	1,273	0,852	0,694	0,362
1.70 V	25,45	16,85	12,54	7,334	4,273	2,545	1,856	1,481	1,253	0,840	0,685	0,358
1.75 V	23,77	15,94	11,94	7,040	4,129	2,477	1,811	1,447	1,226	0,825	0,673	0,352
1.80 V	21,66	14,77	11,17	6,659	3,941	2,388	1,752	1,403	1,192	0,804	0,658	0,346
1.85 V	19,06	13,30	10,20	6,173	3,698	2,272	1,674	1,345	1,146	0,777	0,637	0,336

Constant Power Discharge Characteristics: WPC (25 °C)

F.V	Time											
	5 min	10 min	15 min	30 min	1 h	2 h	3 h	4 h	5 h	8 h	10 h	20 h
1.60 V	47,77	31,23	23,69	14,25	8,47	5,07	3,71	2,97	2,52	1,71	1,40	0,73
1.65 V	47,27	31,10	23,56	14,14	8,40	5,03	3,69	2,95	2,50	1,69	1,39	0,72
1.70 V	45,46	30,18	22,92	13,80	8,22	4,95	3,63	2,91	2,47	1,67	1,37	0,72
1.75 V	43,24	29,06	22,15	13,38	7,99	4,84	3,56	2,85	2,43	1,64	1,35	0,71
1.80 V	40,08	27,39	21,01	12,79	7,66	4,69	3,45	2,78	2,36	1,61	1,32	0,69
1.85 V	35,90	25,12	19,45	11,97	7,24	4,48	3,32	2,67	2,28	1,56	1,28	0,68