



C230 SHD 230Ah | 12V | 1350A

Electrical Specifications

Nominal voltage	12V
Nominal capacity (20h)	230Ah (25°C, 10.5V)
CCA (EN -18°C)	1350A
CCA (DIN -18°C)	750A

Properties

Electrolyte	H ₂ SO ₄
Electrolyte spec density (25°C)	1.28 ± 0.01g/cm ³
Number of plates	33 (16+, 17-)
Positive grid	PbSb
Negative grid	PbCa
Separator	PE (1.4mm)

Mechanical Specifications

Measurements (L x W x H)	513 x 276 x 240mm
Approx. weight	58.1kg
Base hold-down	B00
Layout	3
Terminal type	1
Plug	M27
Technology	Flooded/SLI
Case material	PP (black)
Lid material	PP (black)

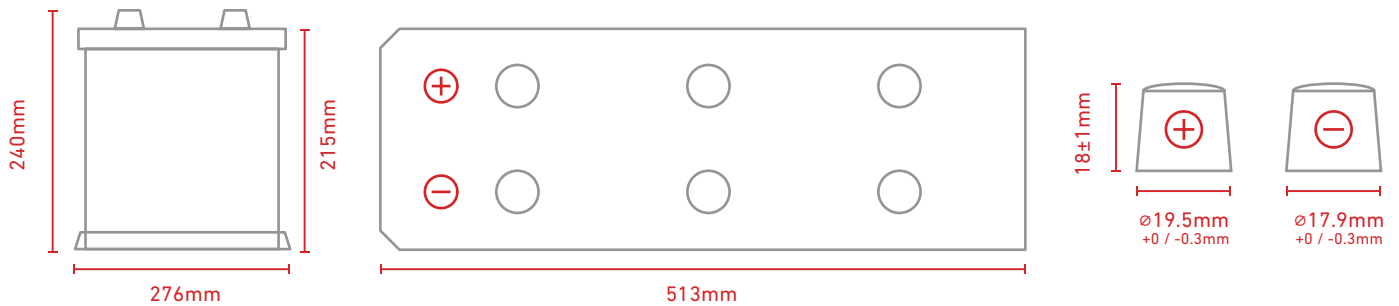

VIBRATION RESISTANT



-18°C TESTED



LOW MAINTENANCE



95% RECYCLABLE



LONG LIFE



BUILT WITH GREEN ENERGY



MADE IN EUROPE

