



S22

22 Ah | 12 V | 20 h

Specifications

Voltage	12 V
Nominal Capacity	22 Ah @ 20 hour-rate
Number of Cells	6
Internal Resistance	Approx. 13 mΩ
Design Life	6 to 8 years (float charging)
Short Circuit Current	830 A
Self Discharge	Monthly rate < 3% @ 25 °C Recharge after 6 months Charge before using

Charging & Discharging

Max. Charging Current	6.6 A
Max. Discharge Current	220 A (5 sec)
Standby Use Voltage	13.7 V to 13.9 V @ 25 °C Temperature Compensation: -3mV/°C/Cell
Cycle Use Voltage	14.6 V to 14.8 V @ 25 °C Temperature Compensation: -4mV/°C/Cell
Reference Capacity	C3 16.7 Ah C5 19.0 Ah C10 20.5 Ah C20 22.0 Ah

Temperature Ranges

Normal Operation	25 °C ± 5 °C
Discharging	-20 °C to 60 °C
Charging	0 °C to 50 °C
Storage	-20 °C to 60 °C

Mechanical Specifications

Measurements (L x W x H)	181 x 77 x 167 mm
Weight	Approx. 6.50 kg
Terminals	T26 (M5)
Case material	A.B.S. UL94-HB, UL94-V0 Optional

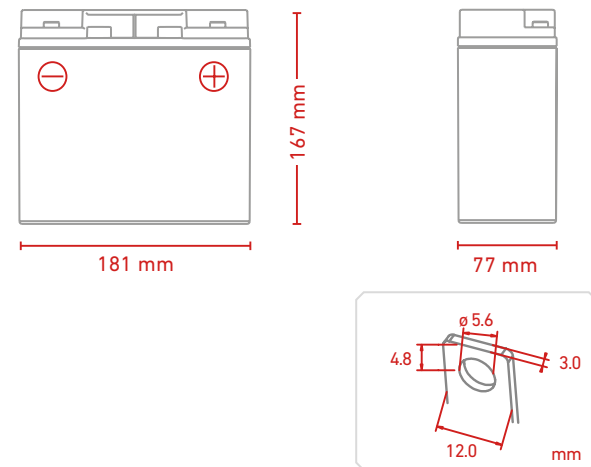

Discharge Characteristics Curve

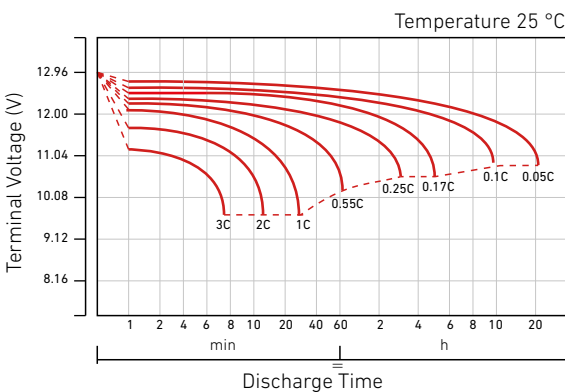

Cycle Life in Relation to Depth of Discharge

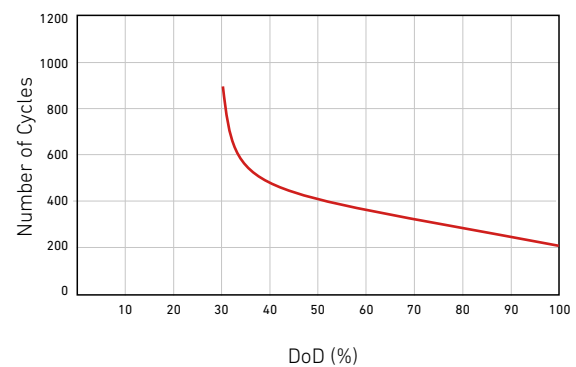

Discharge Characteristics Curve For Standby Use

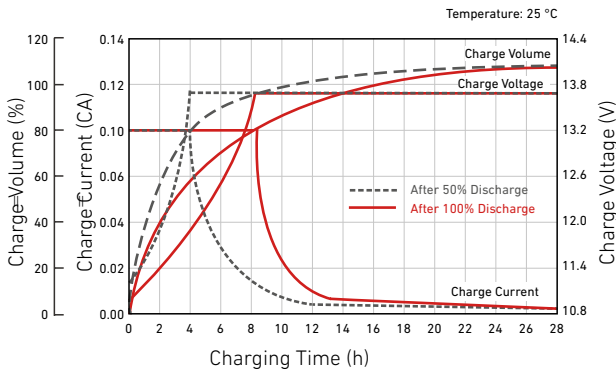

Relationship Between Charging Voltage and Temperature

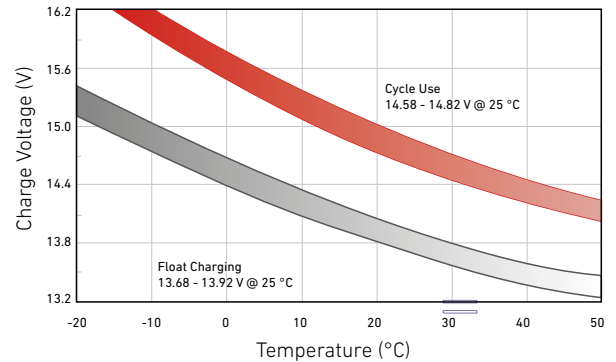

Temperature Effects on Capacity

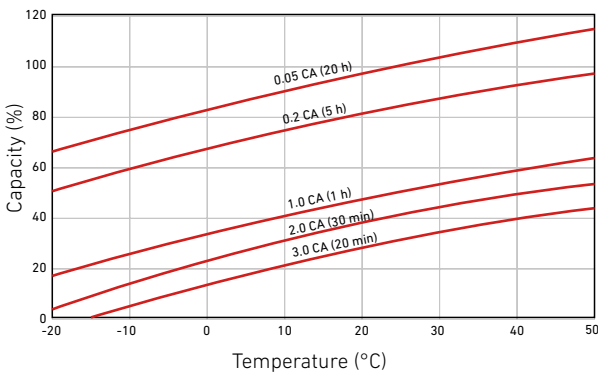

Storage Characteristics

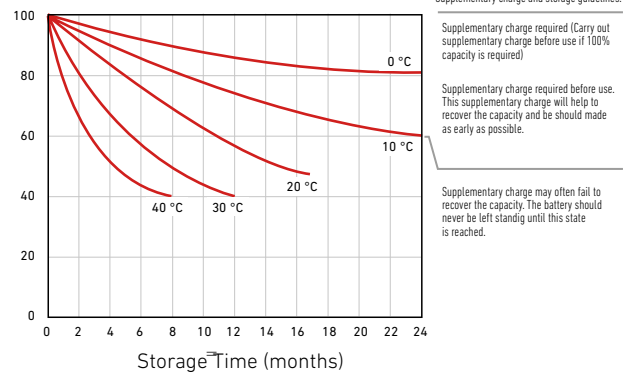

Effect of Temperature on Long-Term Life

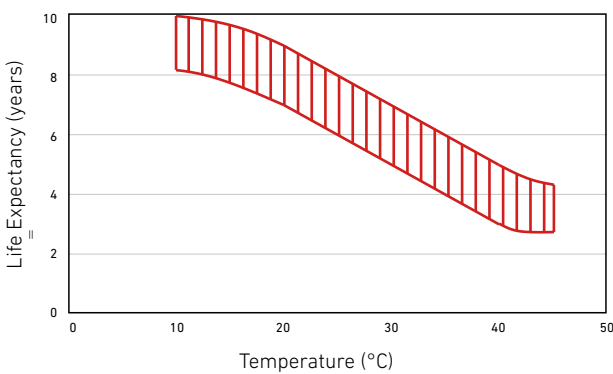

Life Characteristics of Standby Use

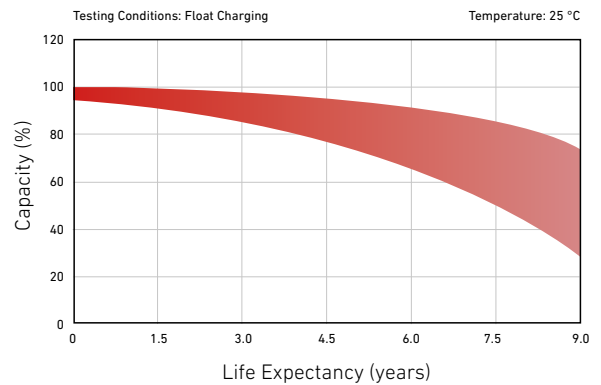

Constant Current Discharge Characteristics: A (25 °C)

F.V	Time											
	5 min	10 min	15 min	30 min	1 h	2 h	3 h	4 h	5 h	8 h	10 h	20 h
1.60 V	79,3	56,04	40,51	23,27	12,77	8,253	6,204	5,009	4,150	2,671	2,169	1,145
1.65 V	73,74	52,96	38,73	22,34	12,33	7,990	6,013	4,873	4,042	2,641	2,143	1,127
1.70 V	66,53	48,75	36,28	21,35	11,93	7,726	5,849	4,741	3,937	2,600	2,110	1,114
1.75 V	59,61	44,63	33,76	20,41	11,49	7,456	5,675	4,619	3,838	2,564	2,083	1,100
1.80 V	52,34	40,4	31,17	19,51	11,05	7,189	5,499	4,487	3,739	2,521	2,056	1,089
1.85 V	41,54	33,01	25,87	16,8	9,915	6,587	5,084	4,170	3,487	2,366	1,936	1,034

Constant Power Discharge Characteristics: WPC (25 °C)

F.V	Time											
	5 min	10 min	15 min	30 min	1 h	2 h	3 h	4 h	5 h	8 h	10 h	20 h
1.60 V	131,5	95,26	70,82	42,26	24	15,64	11,85	9,616	8,000	5,216	4,264	2,255
1.65 V	123,7	91,75	68,71	41	23,31	15,22	11,53	9,391	7,821	5,169	4,218	2,223
1.70 V	114,1	86,02	65,32	39,58	22,69	14,8	11,27	9,170	7,644	5,100	4,160	2,199
1.75 V	104,5	80,16	61,67	38,22	21,99	14,35	10,98	8,969	7,478	5,040	4,110	2,174
1.80 V	93,71	73,83	57,75	36,9	21,27	13,9	10,68	8,743	7,311	4,965	4,063	2,156
1.85 V	75,95	61,41	48,6	32,1	19,2	12,81	9,918	8,157	6,840	4,672	3,830	2,050